

AVION

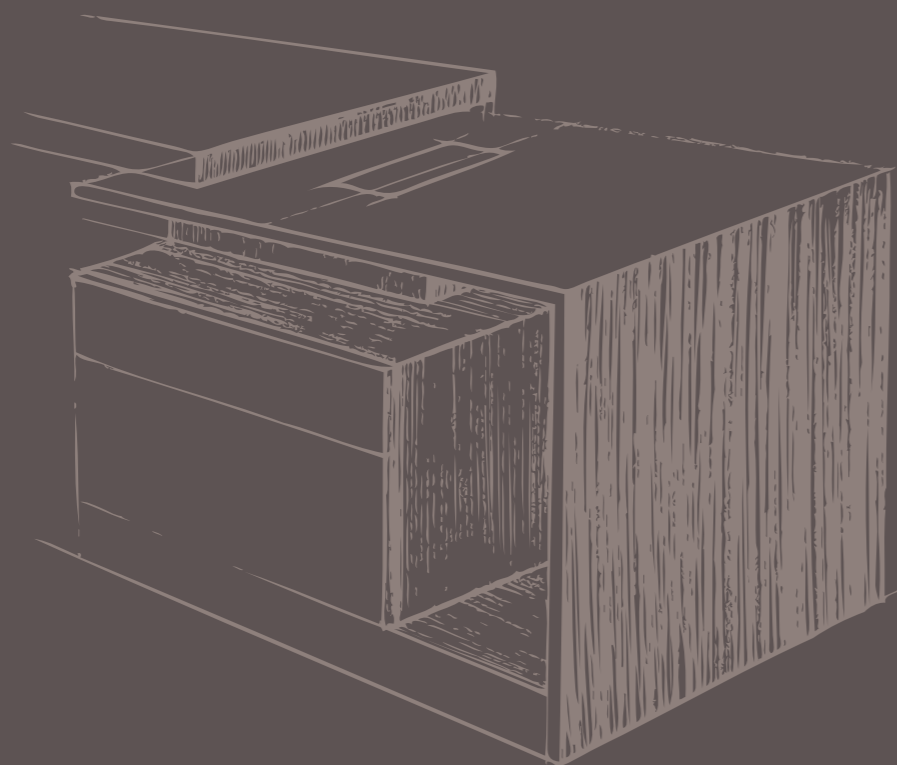

Projektując AVION, myśleliśmy o potrzebach współczesnych liderów i trendach kształtujących obecnie przestrzeń biurową. Stworzyliśmy modułowe rozwiązanie, które dzięki czystej i klasycznej formie wprowadza harmonię do wnętrza i tworzy otoczenie sprzyjające kreatywności i podejmowaniu skutecznych decyzji.

AVION jest modułowym systemem, będącym odpowiedzią na potrzeby i oczekiwania menadżerów poszukujących kreatywnej przestrzeni wokół siebie, która inspirowuje. Ekspresywny charakter tej kolekcji wiąże ze sobą lekkość i śmiałość wraz z klasyczną elegancją, która zapewnia ponadczasowość,

a zastosowanie wielu form i materiałów umożliwia dowolne aranżowanie różnych przestrzeni według indywidualnych potrzeb.



By designing AVION we thought about the needs of today's leaders and trends shaping the current office space. We created a modular solution, which by pure and classical form brings harmony to the interior and creates a favorable environment for effective decision making.

AVION is a modular system, which is a response to the needs and expectations of managers looking for a creative space around them, which inspires. Expressive character of this collection binds together the lightness and boldness with a classic elegance that provides timelessness. The use of multiple forms and materials enables any arrangement of different space according to individual needs.

Bei Entwicklung von AVION dachten wir über die Bedürfnisse der heutigen Managers und Trends der aktuellen Büroraumgestaltung. Wir entworfen eine modulare Lösung, die durch reine und klassische Form die Harmonie in das Innere bringt und ein günstiges Umfeld für eine effektive Entscheidungsfindung schafft.

AVION ist ein modulares System und eine Antwort auf die Bedürfnisse und Erwartungen der Manager, die nach einem kreativen Raum, der inspirierend ist, suchen. Der expressive Charakter dieser Kollektion bindet die Leichtigkeit und die Kühnheit mit einer klassischen Eleganz zusammen und daher bietet die Zeitlosigkeit. Die Verwendung von mehreren Formen und Materialien ermöglicht jede Anordnung verschiedener Räumen nach individuellen Bedürfnissen.

**MARTA DOLNICKA-MARCHAJ**  
**MICHAŁ BIERNACKI**

Autorzy projektu  
Designers  
Die autoren des projekt

















**Biurka wolnostojące**  
Free-standing desks  
Freistehende Schreibtische

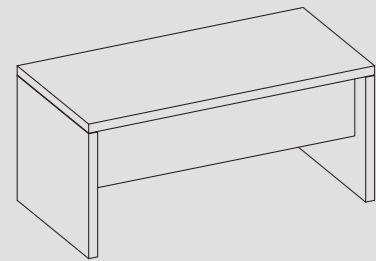

**AN-75** 160/80/H75  
**AN-76** 180/80/H75  
**AN-77** 180/90/H75  
**AN-78** 200/100/H75  
**AN-79** 220/100/H75

**Stolik kawowy**  
Coffee table  
Couchtisch

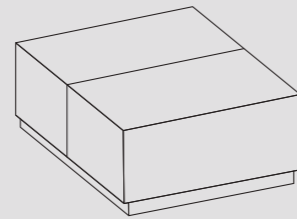

**AN-83** 80/80/H46  
**AN-84** 100/100/H46

**Biurka dostawne**  
Desk extensions  
Anbautische

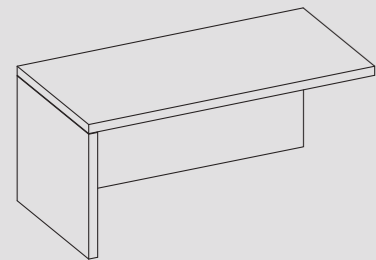

**AN-70** 160/80/H75  
**AN-71** 180/80/H75  
**AN-72** 180/90/H75  
**AN-73** 200/100/H75  
**AN-74** 220/100/H75

**Stoły konferencyjne**  
Conference tables  
Konferenztische

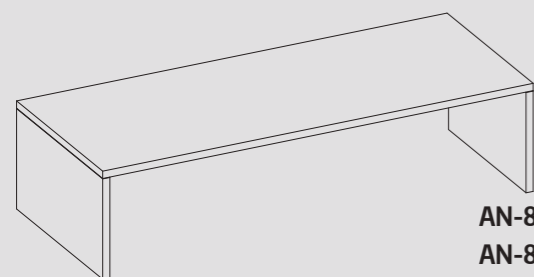

**AN-80** 240/110/H75  
**AN-81** 300/120/H75

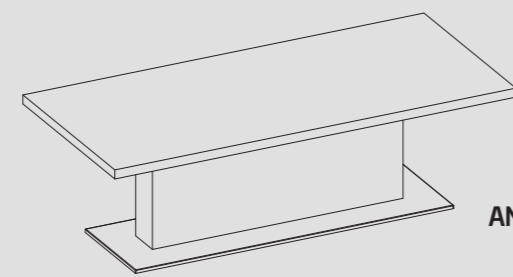

**AN-82** 240/110/H75

**Tory kablowe**  
Cable management  
Kabelkanäle



**AN-95** L80  
**AN-96** L90  
**AN-97** L100  
**AN-98** L110

**Akcesoria**  
Accessories  
Zubehör



**BR-240**  
Przepus kablowy  
Cable access  
Kabeldurchlass

**AN-101**  
Mediaport obrotowy  
Rotbox  
Drehmediaport

**AN-102**  
Mediaport z ramką  
Mediaport with frame  
Mediaport mit Rahmen

**AN-103**  
Mediaport  
Mediaport  
Mediaport

**AN-104**  
Ładowarka  
Charger  
Ladegerät

**Komody podbiurkowe**  
Supporting sideboards  
Stützsideboards

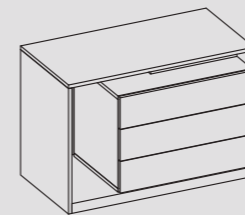

**AN-01** 96,8/50/H66,8

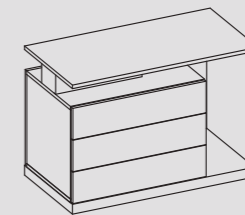

**AN-02** 96,8/50/H66,8

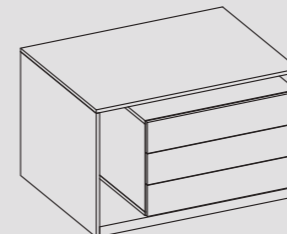

**AN-03** 106,8/80/H66,8

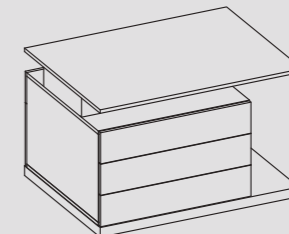

**AN-04** 106,8/80/H66,8

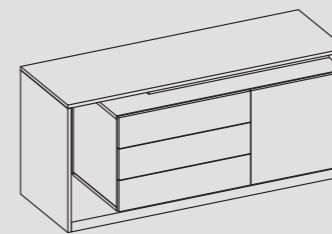

**AN-05** 146,8/50/H66,8

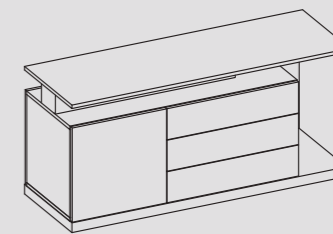

**AN-06** 146,8/50/H66,8

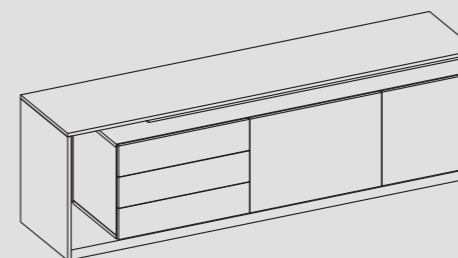

**AN-07** 216,8/50/H66,8

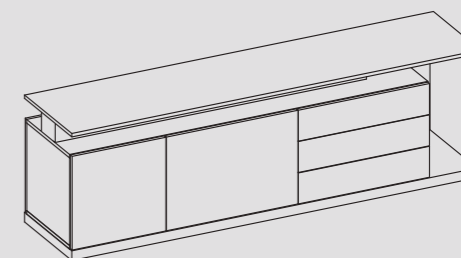

**AN-08** 216,8/50/H66,8

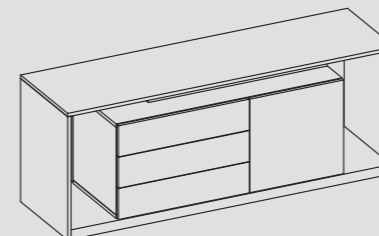

**AN-10** 173,6/50/H66,8

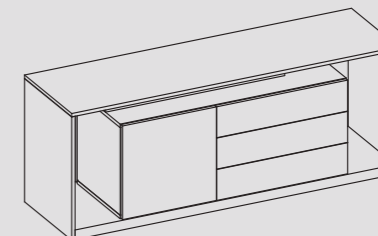

**AN-11** 173,6/50/H66,8

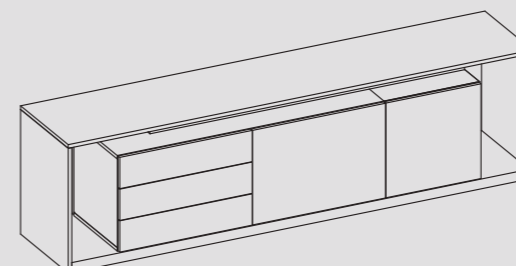

**AN-12** 243,6/50/H66,8

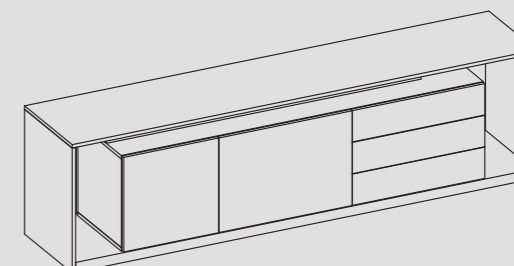

**AN-13** 243,6/50/H66,8

Komody H83,5 cm  
Sideboards H83,5 cm  
Truhen H83,5 cm

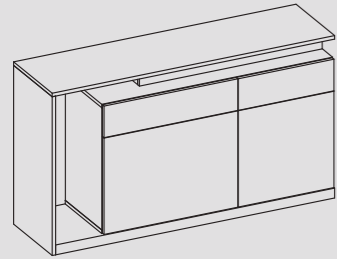

**AN-20** 146,8/40/H83,5

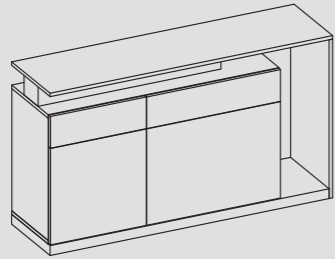

**AN-21** 146,8/40/H83,5

Komody H126,8 cm  
Sideboards H126,8 cm  
Truhen H126,8 cm

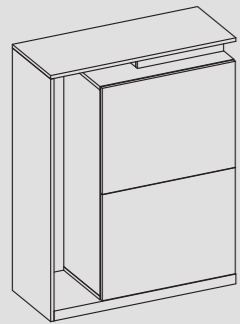

**AN-30** 96,8/40/H126,8

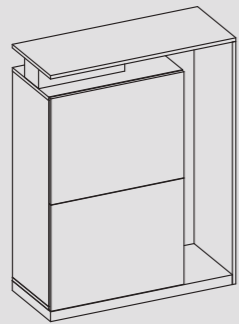

**AN-31** 96,8/40/H126,8

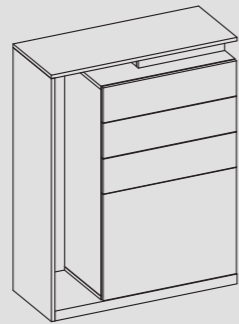

**AN-32** 96,8/40/H126,8

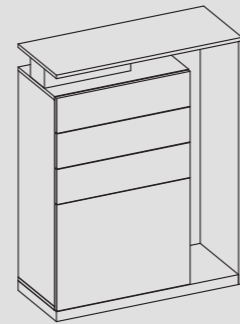

**AN-33** 96,8/40/H126,8

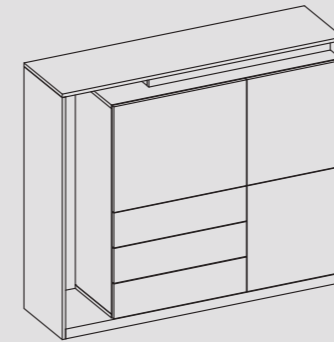

**AN-34** 146,8/40/H126,8

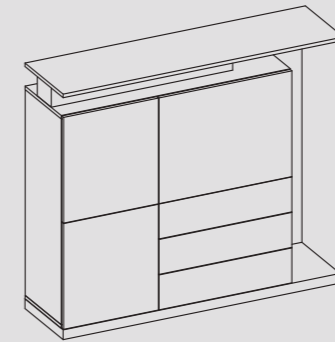

**AN-35** 146,8/40/H126,8

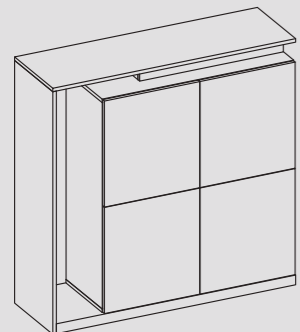

**AN-36** 126,8/ 40/H126,8

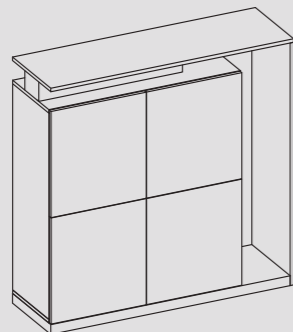

**AN-37** 126,8/ 40/H126,8

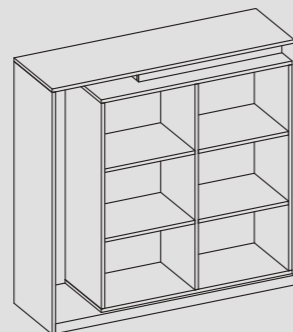

**AN-38** 126,8/ 40/H126,8

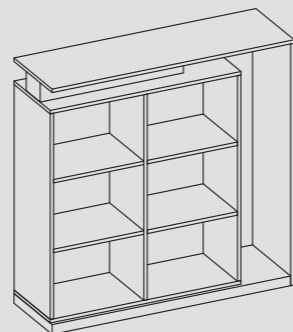

**AN-39** 126,8/ 40/H126,8

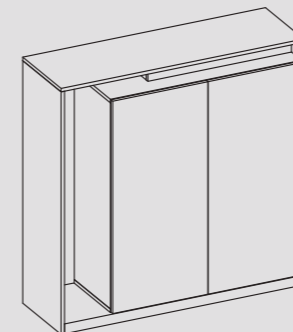

**AN-40** 126,8/ 40/H126,8

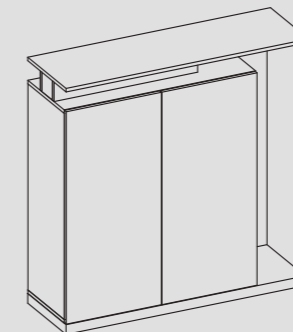

**AN-41** 126,8/ 40/H126,8

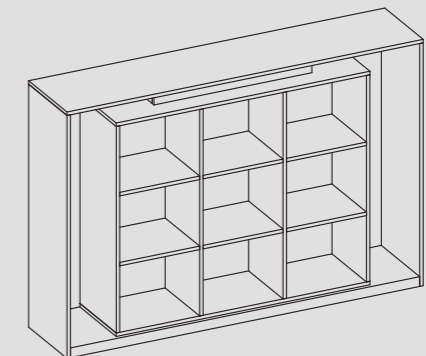

**AN-45** 185,8/40/H126,8

Komody H162,6 cm  
Sideboards H162,6 cm  
Truhen H162,6 cm

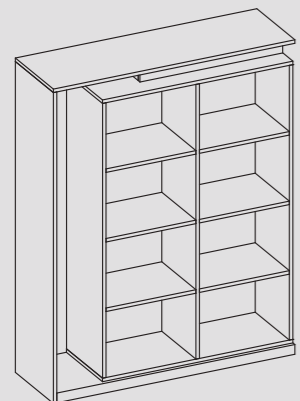

**AN-60** 126,8/40/H162,6

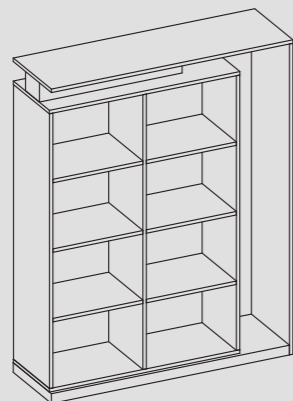

**AN-61** 126,8/40/H162,6

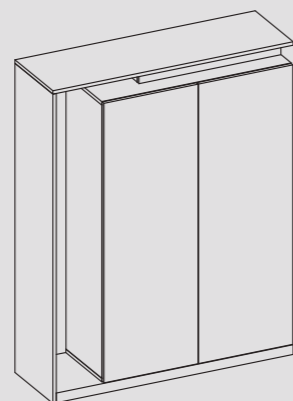

**AN-62** 126,8/40/H162,6

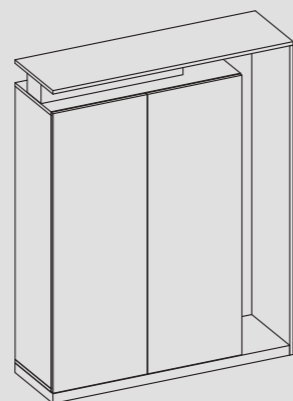

**AN-63** 126,8/40/H162,6

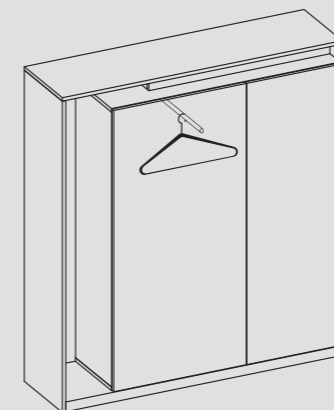

**AN-64** 146,8/40/H162,6

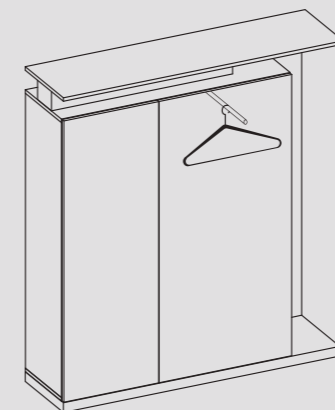

**AN-65** 146,8/40/H162,6

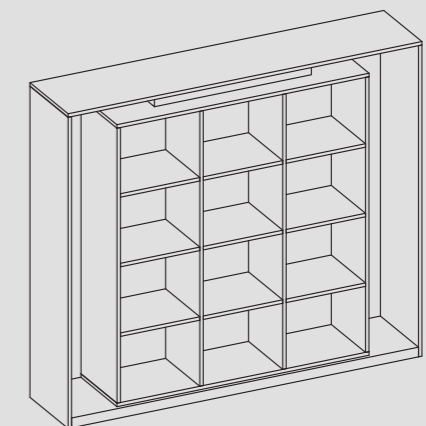

**AN-66** 185,8/40/H162,6

Budget

Melamina / Melamine / Melamin

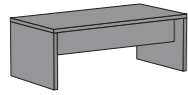

Biurko / Desk / Schreibtisch

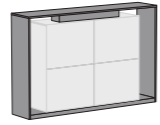

Rama / Frame / Rahmen



Szafki / Cabinets / Schränke

Kanał kablowy  
Cable router  
Kabelkanal



Wiąz Baron / Baron Elm / Baron Ulme



Wiąz Baron / Baron Elm / Baron Ulme



Anracyt / Anthracite / Anthrazit



Anracyt  
Anthracite  
Anthrazit

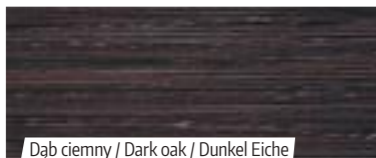

Dąb ciemny / Dark oak / Dunkel Eiche



Dąb ciemny / Dark oak / Dunkel Eiche



Biały / White / Weiß



Biały  
White  
Weiß



Dąb dziki / Wild Oak / Wild Eiche



Dąb dziki / Wild Oak / Wild Eiche



Lawa / Lava / Lava



Nevada  
Nevada  
Nevada



Dąb Sonoma / Sonoma oak / Sonoma Eiche



Dąb Sonoma / Sonoma oak / Sonoma Eiche

Prestige

Melamina / Melamine / Melamin



Czekolada / Chocolate / Schokolade



Czarny / Black / Schwarz



Czekolada / Chocolate / Schokolade



Anracyt  
Anthracite  
Anthrazit



Dąb afrykański / African oak / Afrikanische Eiche



Biały / White / Weiß



Dąb afrykański / African oak / Afrikanische Eiche



Biały  
White  
Weiß



Beżowy / Beige / Beige

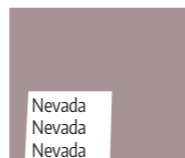

Nevada  
Nevada  
Nevada

Exclusive

Okleina naturalna / Natural veneer / Naturfurnier



Jesion czarny / Black ash / Schwarz Esche

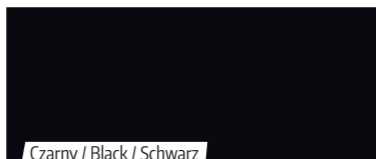

Czarny / Black / Schwarz



Jesion czarny / Black ash / Schwarz Esche



Anracyt  
Anthracite  
Anthrazit

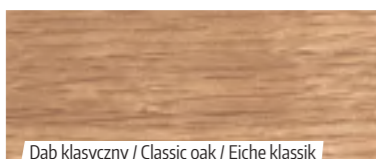

Dąb klasyczny / Classic oak / Eiche klassik



Biały / White / Weiß

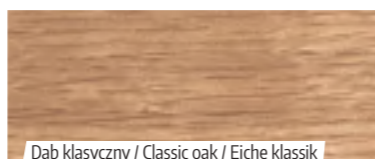

Dąb klasyczny / Classic oak / Eiche klassik



Biały  
White  
Weiß

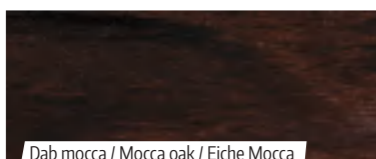

Dąb mocca / Mocca oak / Eiche Mocca



Beżowy / Beige / Beige

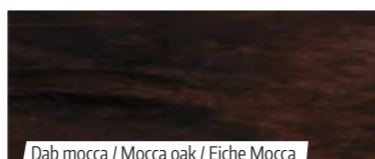

Dąb mocca / Mocca oak / Eiche Mocca

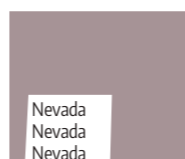

Nevada  
Nevada  
Nevada

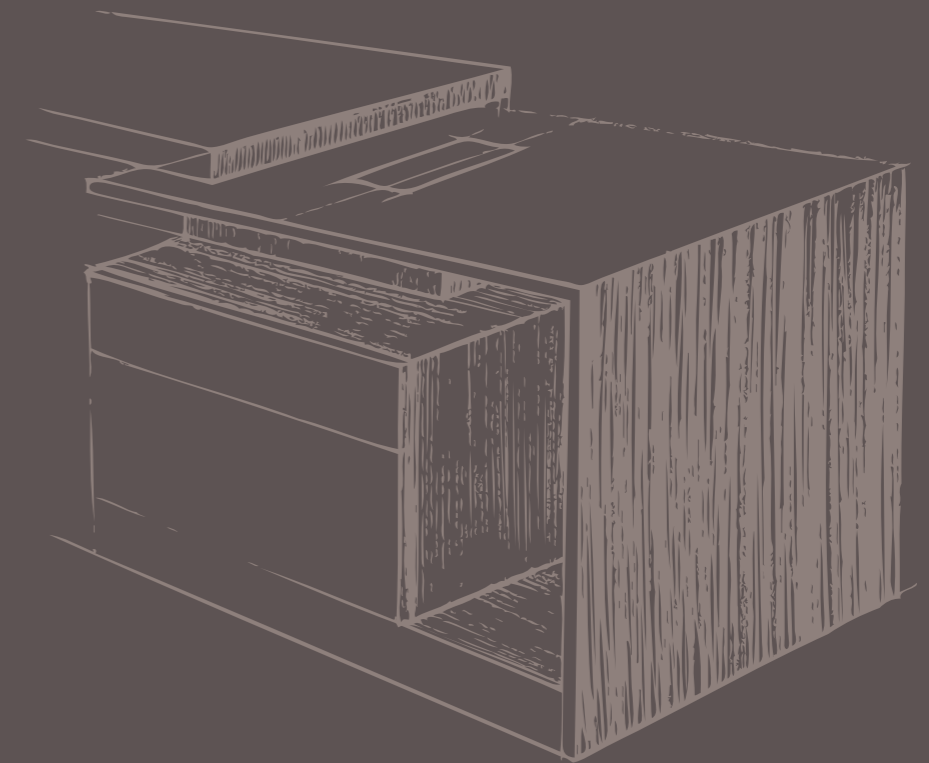

Mebelux Sp. z o.o. realizuje politykę ciągłego rozwoju produktów, dlatego zastrzega sobie prawo do zmian technicznych oraz kolorystyki. Informacje zawarte w niniejszej broszurze mają wyłącznie charakter informacyjny i nie stanowią oferty w rozumieniu kodeksu handlowego. Z uwagi na ograniczenia techniki druku offsetowego kolory przedstawione w tym wydawnictwie mogą nieznacznie różnić się od kolorów rzeczywistych produktów. Wydanie maj 2016.

This publication is issued to provide outline information and is not deemed to form any part of any offer and contract in the legal sense. The company has a policy of continuous product development and improvement and we therefore reserve the right to vary any information without prior notice. Product colors shown throughout this catalog may vary slightly from actual products due to inherent limitations in photography and offset printing. Issued May 2016.

Diese Veröffentlichung dient lediglich zu Informationszwecken und ist kein Teil des Angebots und Vertrags im rechtlichen Sinne. Das Unternehmen verfolgt eine Politik der kontinuierlichen Produktentwicklung und Verbesserung und behält sich daher das Recht vor, Informationen ohne vorherige Ankündigung zu ändern. Aufgrund der inhärenten Beschränkungen in der Fotografie und Offsetdruck können die Farben in diesem Katalog von den tatsächlichen Produkten geringfügig abweichen. Ausgabe Mai 2016.

**mebelux**<sup>®</sup>



Mebelux Sp. z o.o.  
ul. Przemysłowa 9, 14-100 Ostróda  
tel 89 646 12 22, fax 89 642 83 53  
e-mail: mebelux@mebelux.com.pl  
www.mebelux.com.pl



Znak odpowiedzialnej  
gospodarki leśnej

Szukaj produktów z logo FSC<sup>®</sup>